

SANOMAT
Cream whipping machines

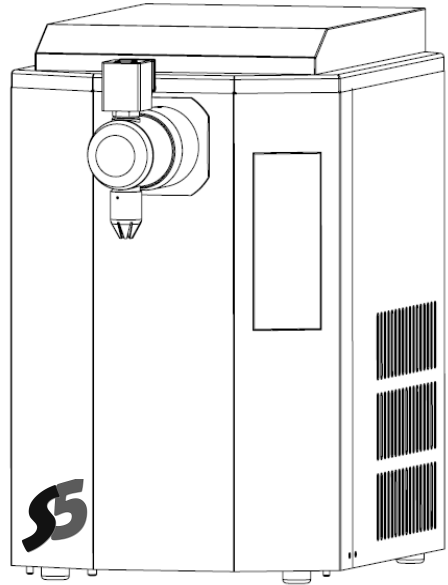

Vaihinger GmbH
Horstweg 29
65520 Bad Camberg-Erbach
Germany
Phone: 0049 (06434) 9405-0
Fax: 0049 (06434) 9405-99
<http://www.sanomat.com>
info@vaihinger.com

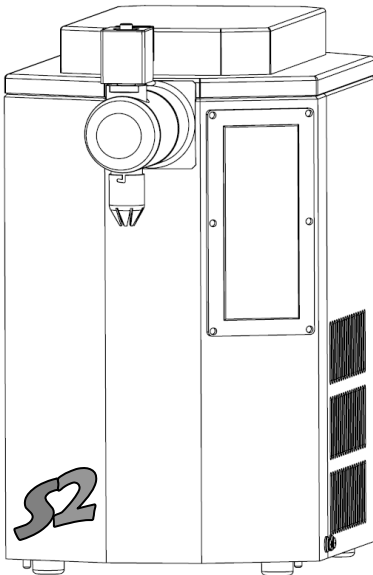

SANOMAT

Cream whipping machine
SANOMAT S-class 2/5/10

Operating instructions



The correct handling of cream and your SANOMAT

You are a proud owner of an efficient, energy saving cream whipping machine. To achieve the very best results we suggest the following:

Cream is a natural product that varies with the season such as forage mixtures for the dairy cows. This can have an effect on the quality of the cream and therefore have an influence on whipping volume and stability.

Basically we suggest using fresh cream with a temperature between +3° to +5°C and with a fat content between 30 % and 36 %. If you would like to use homogenised cream we recommend products of nameable producers because other products often cause a dissatisfying result.

Please note:

The cold chain from the dairy to you must absolutely be kept, because just a short warming can perish the cream culture and could make a whipping impossible.

To avoid a contamination with bacteria carry out the daily disinfection cleaning after closing hour and also the regular cleaning of air regulation. (to find from page 13 on)

On the following sides we lead you step by step through the right exposure with your new SANOMAT.

Your Vaihinger Team



I n d e x

Unpacking and checking	5
Intended use of your SANOMAT	5
Safety first!	6
Setting up and connecting	7
Touch-Screen	8
Preparation for use	9
o Capsule protection program	9
o Temperature alarm	9
o Shock cooling program	9
Day/night mode	10
First filling	11
Adjust whipped cream consistency	12
Take serving sizes	12
Cleaning and service (overview)	15
Daily disinfection cleaning	16
Monthly air regulation cleaning	20
Master cleaning and technical checking	21
Setting parameter	26
Troubleshooting	29
Shipping information	31
Disposal instructions	31
Technical data	31
Spare parts	32
Order numbers	34
Declaration of conformity	35
Machine explanation	37



The machine and its parts

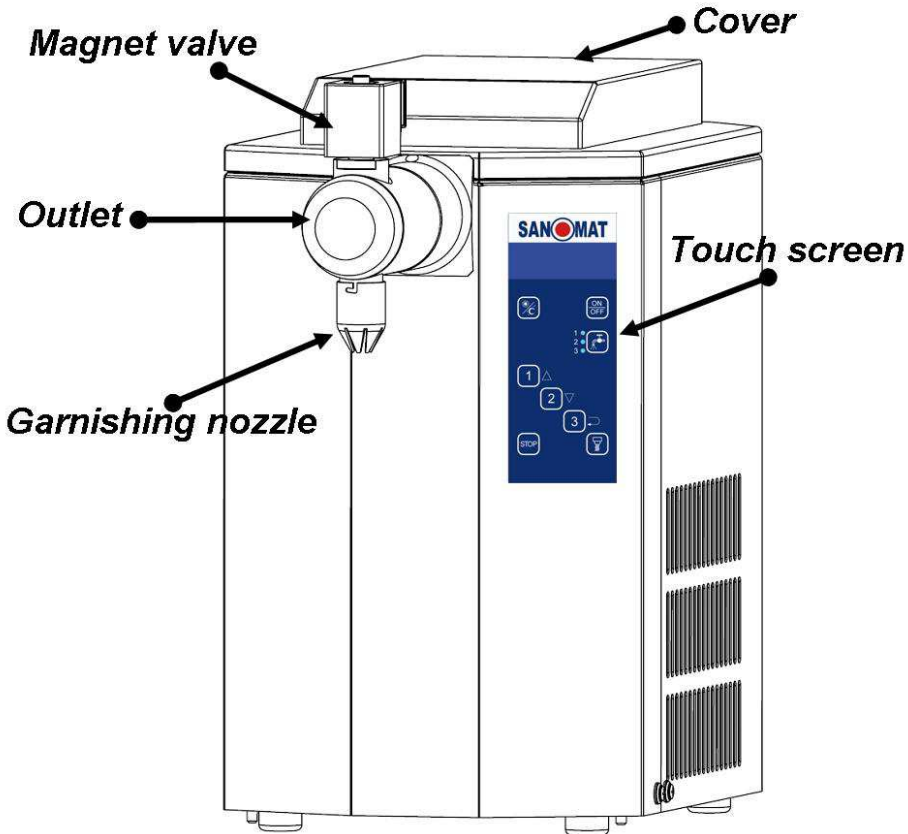

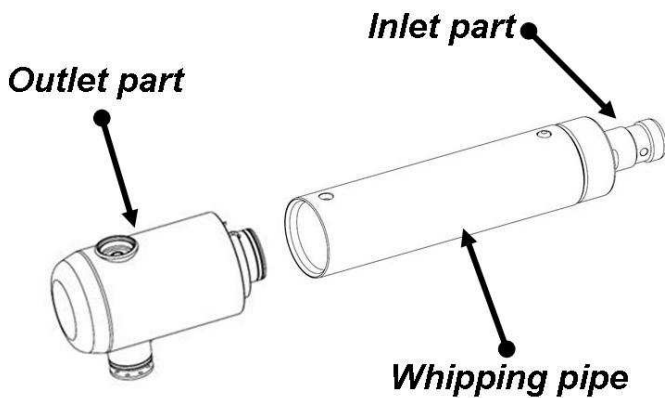
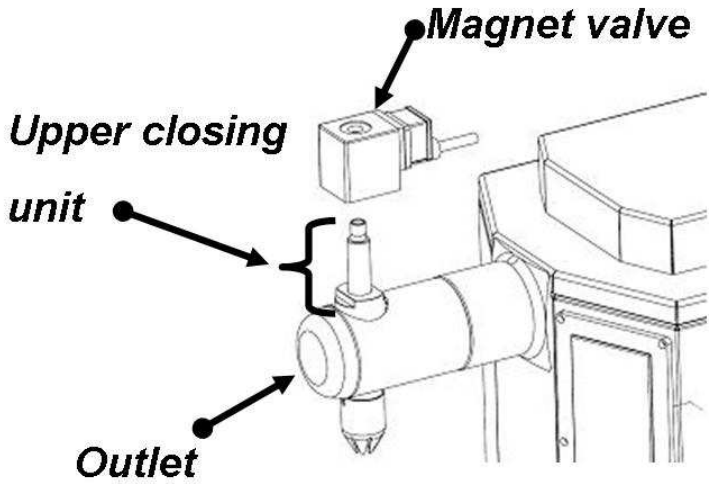

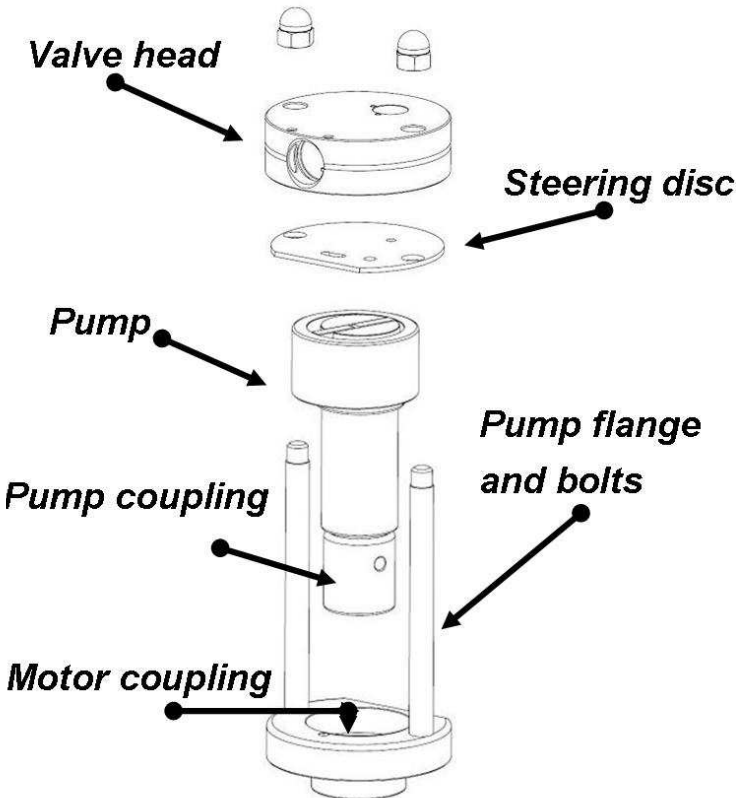
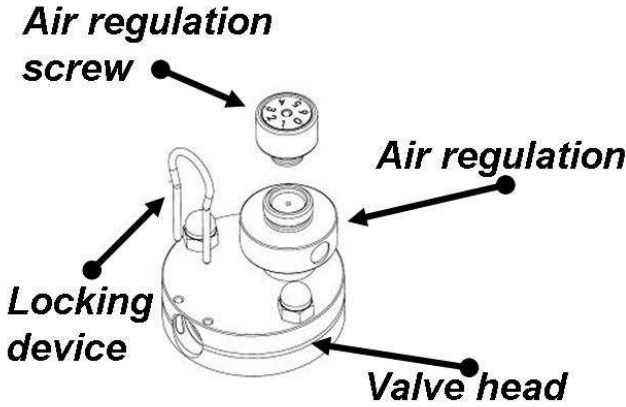



Unpacking and checking

- Cut the straps with a pair of scissors and lift the carton straight-up.
- Carefully lift the SANOMAT out of the Styrofoam base and check the SANOMAT for shipping damage. If applicable submit a claim to the transport company.
- Check that you have received all of the following:
 - ✓ operating instructions and shipping documents
 - ✓ disinfection-cleaner (0,25 litre SANO-DESINFEKT-Plus)
 - ✓ bag with:
 - socket wrench
 - spanner
 - pusher
 - Cleaning nozzle
 - cleaning brushes
 - gaskets (O-rings)
 - Vaseline
- ✓ cleaning bucket (*only S5 and S10*)

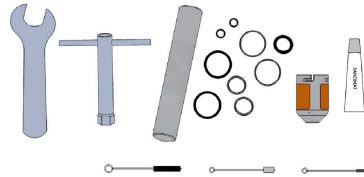









Intended use of your SANOMAT

- The SANOMAT has to be operated at an environmental temperature up to max. 40°C
- The SANOMAT is a technical means of work. Its bringing into circulation serves **exclusively for the use in commercial business**.
- Do not run the SANOMAT in rooms with explosive atmosphere. The use of the SANOMAT according to determination is restricted to persons older than 14 years.



Safety first!

Mostly annoying but always important: the safety regulation.
They ensure safety and ongoing satisfaction with your SANOMAT - so please keep this in mind:

-  **Do not shut SANOMAT off during the night!**
This gives additional hygienic protection. Unit should only be turned off when not in use for several days!
-  **Do not use SANOMAT for other purposes!**
Every attempt to do so may cause damage!
-  **When cleaning or repairing unit, use only original Vaihinger-SANOMAT spare parts and accessories!**
Using other parts may lead to damage! Also, this could cancel the warranty and the official approval of the cream machine.
-  **Never use hose or steam power washer to clean SANOMAT!**
Injury to people and damage to the unit may result if water gets into electric components!
-  **Only trained personnel should be allowed to operate the SANOMAT!**
Give your staff proper training. This manual will help you in this regard.
-  **The security of use and function has to be ensured by regular maintenance.**
-  **Follow operating instructions closely!**
-  **Install the SANOMAT in a way that wall socket stays accessible (cut of power supply in case of need)!**



Setting up and connecting

- Ensure the SANOMAT is safely standing on it's four feet on a plain and stable surface. Please pay attention to:



Fire danger due heat accumulation!
Keep sidewise clearance distances!
Left and right minimum 5 cm!

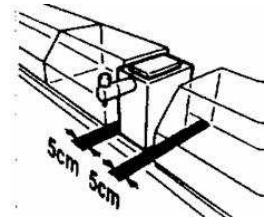

Avoid direct sunlight!

- Make sure your socket is properly grounded and has got the right power supply:

230V ~ / 50Hz, fuse at least 10A.

110-120V/60Hz / 100V/50/60Hz, fuse at least 15A



Before start-up, let unit stand idle for 2 hours!

This time is needed for the refrigeration unit to recover from movement during transport!

- Remove any dust which may have come from packaging material. Plug in cord.



Please carry out the daily disinfection cleaning before initial fill! (See page 16 “daily disinfection cleaning”)

⇒ ***Your SANOMAT is ready for use!***



Touch-screen

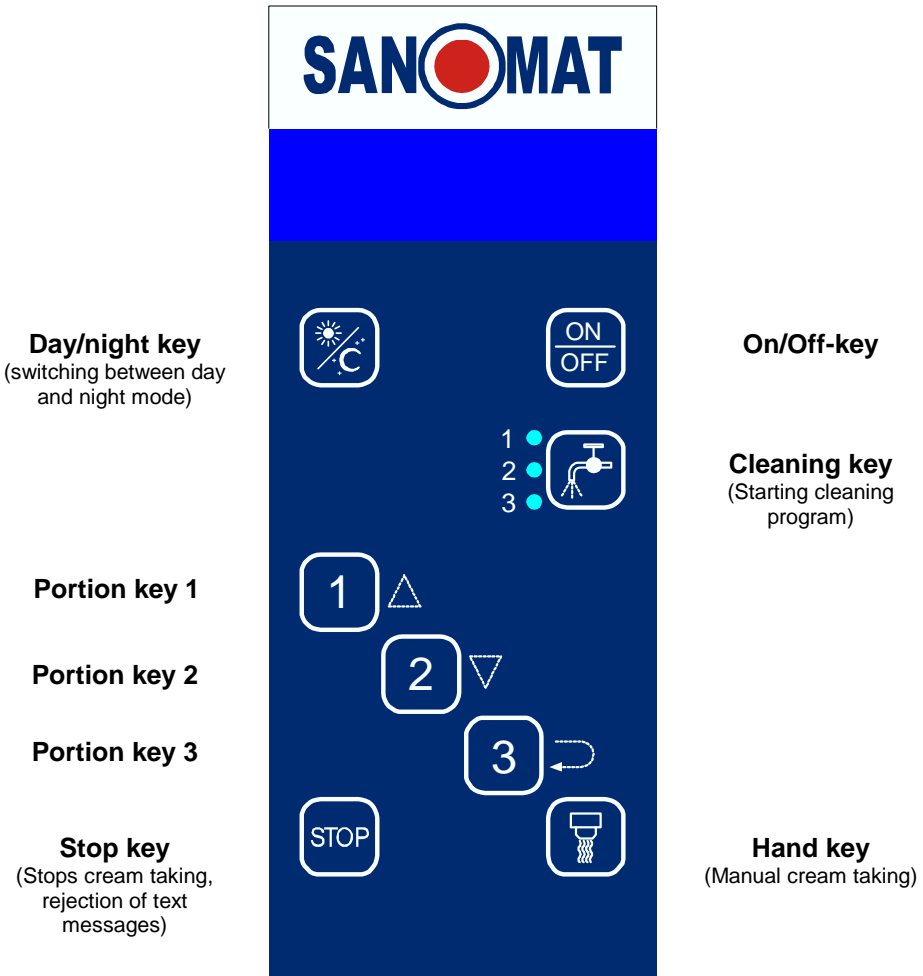

The operating of your cream whipping machine happens through the touch-sensitive key-field module. This module is made of hardened mineral-glass and is very robust and easy to clean. Just lightly tip the keys.



Preparation for use

Connecting for the first time:

After connecting the plug the machine is in the OFF-mode. The cooling is out of action, the display shows OFF.

To turn your S-class on or off hold key ON/OFF for about 3 seconds. Your S-class will skip into the day mode / will turn off. After turning on the machine for the first time your S-class will be in the day mode. The cleaning request appears.

**⚠ The cooling will not turn on until the first cleaning!
(Instructions for disinfection cleaning from page 16 on)**

Alternative you can reject the cleaning request with the stop key. CAUTION: This does NOT replace the cleaning and does NOT accord to hygienic standards!

Capsule protection program (protection program for cooling system):

Your SANOMAT S-class has a capsule protection program. This program makes sure the cooling takes a 2 minute break between turning off and on, so that the compressor of the refrigerant circuit is protected against overcharge and defect. Should the circuit be interrupted (e.g. at a blackout) the capsule protection automatically interrupts the cooling for 2 minutes to rebuild the pressure balance.

Temperature alarm:

Should you accidentally fill too warm liquid cream into the cream container or was your SANOMAT longer out of action the message “temperature alarm” appears on the display. This message means the temperature in the cooling area is over 7°C and the shock cooling program will be started.

Shock/quick cooling program:

The shock cooling program makes sure that at too high liquid cream temperatures an intensive cooling interval will be activated. In this interval the cooling runs for about 10 minutes and pauses then for maximal 15 minutes. Through this interval the machine achieves significantly faster its operating temperature.



The day mode



Generally you can take cream at the day mode.

Should there be no other messages the display shows the cream temperature in rotation with the time. Should the cream temperature be higher than a presetted release-temperature all three indication LEDs are blinking as a warning that the ideal cream temperature isn't reached yet. As soon as the release temperature (<7°C) is reached, all LEDs lapse.

These indications do not have any influence onto the machine operation!

The night mode



Switch between day and night mode by tipping the key day/night.

In this mode taking cream is disabled but the cooling stays on. Provided that there are no other notifications the display shows the moon-symbol for the night mode in rotation with the temperature.

In the night mode several functions are available:

- you can start the daily disinfection cleaning
- you can start the cleaning of the air regulation
- you can change the parameters, e.g. time and date or the size of the portions (please have a look from page 26 on)

Through typing in a password by the hand key and the portion keys you'll get access to the parameter level.

Generally your S-class shows the demand for the disinfection cleaning in the night mode. You can clean your machine now if you haven't done it yet or you push the stop key to reset the demand. The cooling starts and notifications might appear, e.g. the demand for cleaning of the air regulation.



First filling

Before the first filling we suggest to fill the cream container with cold water (about 5-6°C) and put it into the machine. Your SANOMAT will reach much faster its ideal operating temperature then.

After the operating temperature is reached, the unit will turn off and on as needed – via thermostatic controls. This serves to keep the temperature at an optimum level.

- Swing suction pipe up and remove cream container. (fig. 1)
- Fill cream container with **cool** cream (between +3°C and +5°C).
- Place filled cream container into SANOMAT and swing suction pipe into it. (fig. 2)

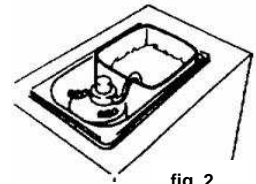
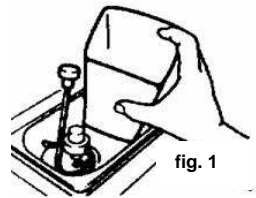

Sweetened cream:

- If you wish to add sweetener, add sugar-syrup to the **cool** cream being still in its original packing and mix thoroughly (sugar-syrup with 75-80% sugar).

⚠ Do not use icing sugar or regular sugars. This may cause damage to pump through undissolved sugar-crystals!

Please note the inner cooling space, in which the cream container stands, shall not be filled with liquids!



Adjust whipped cream consistency

- i** The adjustment of the air regulation acts in accordance to the fat content of the used cream and the desired stability. Cream with a lower fat content than 30 % needs a higher air supply, whereas cream over 32 % needs a lower air supply.
- Turn air regulation screw clockwise to "0" (=closed), then turn air regulation screw back to desired position (numbers point to the outlet, see fig. 3).



fig. 3

- ➔ Best results are achieved at settings "3" to "4". Determine preferred consistency by trying different settings.
- ➔ Often, quite a small adjustment- less than 1 millimetre will be enough!
- ➔ Using too much air causes sputtering or the cream is whipped too stable, resp. the cream can turn into butter and the machine has to be completely cleaned!
- ➔ Cream will be too soft or liquid when using too less air.
- ➔ Without air, cream will not be whipped, and the pump is being overworked unnecessarily. - Therefore:

⚠ Do not leave air regulation screw in position "0"

Taking serving sizes

By the function HAND/MANUAL you can dispense as much whipped cream as you just need.

- Push hand key (fig. 4)
- ⇒ The SANOMAT will produce whipped cream until hand key will be released.



fig. 4



Would you like to prepare a higher capacity of whipped cream, e.g. for preparing a cream cake, there are two possibilities:

1. Time controlled cream taking:

With this option it's possible to take an earlier defined value of liquid cream. You need not to stay at the machine during this time so you could go and get other ingredients or serve customers.

How to define the time: E.g. fill 1 litre liquid cream into the cream container. Take a stopwatch, push and hold the key hand, than portion key 2 and let both go. The "permanent-taking" begins. As soon as the cream container runs empty, push key stop at the SANOMAT and at your stopwatch. Did the cream taking take e.g. 24 seconds you can enter this value into parameter P4.

Cream taking:

Press and hold key hand, than portion key 1, release both keys - your S-class will deliver cream for the preseted time (parameter P4).

Please note: Should the cream container be empty after e.g. 15 seconds, but you have set a time of 30 seconds the pump could be irreparably damaged!

2. Permanent-taking:

Please control your SANOMAT during the permanent-taking, that the pump an not run dry!

For a permanent-taking please push and hold the keys hand and portion 2. This operation can only be stopped by the key stop. During the permanent-taking you can refill the cream all the time so you can produce a larger value of whipped cream.



Caution! Never leave the machine uncontrolled in this case! No control can cause damaging of the pump!



In case of nonobservance of the hazard notes the warranty claim ceases!

SANOMAT

Cream whipping machines



Three portion keys are available for different portion sizes (fig. 5). The progress is shown at the display.



- The weight of the cream portion sizes (as pre-adjusted) refers to fresh cream (no UHT-cream) with 32% fat content!
- According to cream quality resp. position of the air regulation screw the cream portion (from the same portion key) may vary in its weight for +/-2 grams!

- Shortly press a portion key
⇒ The SANOMAT produces exactly the chosen portion.

or:

- Press and hold a portion key
⇒ The SANOMAT produces the chosen portion several times until the portion key will be released.

You can adjust the portion sizes (fixing of dosage time) individually by changing the parameter P1 to P3 in the parameter level (from page 26 on).

Tip: You can stop the cream taking at any time by pushing the key stop.



Cleaning and service (overview)

Your SANOMAT should always operate trouble-free. In addition, it must always meet highest hygienic standards. Therefore:

 Pay close attention to cleaning and maintenance instructions!

The summary below should help you in this regard:

When	What	See
Daily	Disinfection cleaning	from page 16 on
Monthly	Cleaning of air regulation	from page 20 on
Before extended shutdown	Disinfection cleaning, cleaning of air regulation	from page 16 on
After extended shutdown	Disinfection cleaning	from page 16 on
In case of trouble	Master cleaning and technical checking	from page 21 on

And remember:

 When cleaning, use only original Vaihinger-SANOMAT supplies!
 Using other supplies can lead to equipment damage! Also, this could cancel the warranty and the official approval of the cream machine.

 Never use hose or steam power washer to clean SANOMAT!
 Injury to people and damage to the unit can result if water gets into electrical components!



Daily disinfection cleaning

Your SANOMAT S-class is able to remind you at your personal preset time to clean the machine. Should you wish to activate this setting (e.g. at 12 o'clock) you can set the time at parameter P10.

Generally the cleaning demand appears each time you switch into the night mode.

During the cleaning the cooling unit is automatically switched off. The cleaning happens in three phases: pre-cleaning, main cleaning and final cleaning.

Each cleaning phase is started by pushing the cleaning key (fig. 6). The request for this is shown at the display. Simultaneously the related LED flashes and signals, that the next cleaning phase is to be started.

As soon as the cleaning has finished all three LEDs lapse.

The cleaning can be stopped at any time by pushing the stop key.

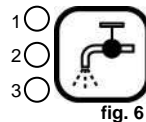

IMPORTANT: The notification at the display is just a small reminder! Please proceed the disinfection cleaning exactly according to the manual. If not following these instructions, following problems can occur:

If cream remnants are allowed to remain in the system, bacteria will form quickly! This results in:

- poor quality of whipped cream
- health risks to customers!

⚠ SANOMAT is to be cleaned according to these instructions at the end of each working day!

⚠ Never leave SANOMAT dirty overnight!

⚠ Never clean touch-screen with a wet cloth!

SANOMAT

Cream whipping machines



Preparation:

- Remove cover and put a 5-litre pail under the outlet.
- Swing up suction pipe and clean its outside with a paper towel. Press and hold key hand until suction pipe is empty.
- Remove suction pipe and cream container. Wash both under hot running water.

Pre-cleaning:

- Switch the machine into the night mode (fig. 7). The cleaning demand appears at the display. Press and hold the cleaning key for 3 seconds. The notification „Put cream container filled with 1,5 L warm water (50°C/120°F) into machine + press cleaning button“ appears at the display. LED 1 is blinking.
- Fill cream container with 1,5 l warm water (max. 50°C), put it back into the SANOMAT, plug-in suction pipe and swing it in.



fig. 7

⚠ Do not fill the container with hot water (max. 50°C)!

- By tipping the cleaning key (fig. 8) anew you'll start the pre-cleaning. The cleaning program will run automatically (duration about 3 minutes). The notification "pre-rinse" appears now at the display, LED 1 is glowing permanently.
- After the pre-cleaning you will be notified of the next step by the display.



fig. 8

Main cleaning:

- Replace garnishing nozzle with cleaning nozzle (fig. 9)

⚠ Never use cleaning nozzle with cream!

- Clean the garnishing nozzle under hot running water.
- Fill cream container with 1,5 l warm water (max 50°C) and add 40 ml SANO-DESINFEKT-Plus. (fig. 7)

Tip: 40ml (1 ½ oz) = 4cl = 2 small glasses of 2cl

⚠ Do not use or mix-in any other disinfectant agent!

- Those steps are displayed as follows: „Attach cleaning nozzle + put cream container with 1,5 L warm water (50°C/120°F) + SANO-Desinfekt-Plus into machine + press cleaning button“, LED 2 is blinking.
- Tip the cleaning key shortly. The main cleaning runs automatically. The notification "Main cleaning" appears in the Display, LED 2 glows steadily.

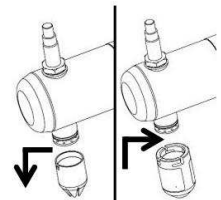

fig. 9

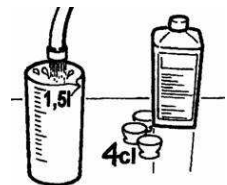
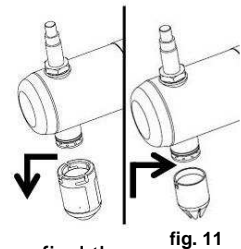

fig. 10



Final cleaning:

- Remove suction pipe and cream container from the SANOMAT. Wash both under hot running water.
- Fill cream container with 1,5 l cold drinking-water and put it into SANOMAT. Plug-in suction pipe. The related notification “Put cream container filled with 1,5 L cold water into machine + press cleaning button” appears at the display. LED 3 blinks.
- Tip the cleaning key shortly. The final cleaning begins and runs automatically. The notification “Final rinse” appears. LED 3 is glowing permanently.
- After that remove cream container. Soak a clean towel with disinfection cleaner and wipe the interior of the SANOMAT.
- Now you will be asked to replace the cleaning nozzle with the garnishing nozzle (fig. 11), place cream container filled with cool liquid cream into the machine and press the cleaning key. The notification is as follows: “Attach garnishing nozzle + put cream into machine + press cleaning button”. Now you can replace the cover. The cleaning is finished, the 3 LEDs lapse (except at temperature alarm, please have a look at page 9)
- Each 28 days the demand for the cleaning of the air regulation appears after the finishing of the disinfection cleaning. This is also confirmed by the cleaning key. You can find the instructions of the air regulation cleaning from page 20 on.



IMPORTANT: Only push stop key in case of emergency! By pushing the stop key the system thinks the machine was not cleaned and will continue to demand you to clean the machine!

- After the cleaning the machine is still in the night mode. The cooling is kept up and you can leave the machine over the night or the weekend without any concerns.
 - ✓ The disinfection cleaning is now complete. Your SANOMAT can be used again.
- Would you like to take cream afterwards, press the day/night key for 3 seconds. The machine switches into the day mode and cream taking is enabled.

Tip: You intend to use your SANOMAT the next day? Prepare it today for this purpose!

SANOMAT

Cream whipping machines



- The SANOMAT stays switched on. Place container with **cool** cream into SANOMAT (see page 9: "Getting ready to start unit")

The next day:

- Stir the liquid cream thoroughly.
 - ✓ Your SANOMAT is ready for use!

Switching off:

Should it be necessary to switch off your S-class totally, e.g. at plant holidays, follow these instructions:

Remove any cream out of the machine and run a complete disinfection cleaning and air regulation cleaning. Press key ON/OFF 3 seconds - your S-class is now completely switched off. Now you can disconnect the plug.



Monthly air regulation cleaning

Disassembly

- Carry-out a complete disinfection cleaning.
- Remove air regulation screw and locking device (fig. 12).
- Pull-out air regulation case.
- Push locking device from the bottom into the air regulation case and remove the non return valve and air nozzle disc (fig. 13).

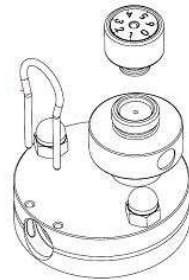

fig. 12

Cleaning

- Clean the opening in the air nozzle disc with the smallest brush (fig. 14).
- Clean all parts with SANO-DESINFEKT-Plus. Thoroughly rinse all parts with running hot water.



fig. 13

Reassembly

- Turn the air regulation case so that it clicks into proper position:

⚠ The hole for suction pipe goes to the right, not to the back! (fig. 15)

- Re-install all other parts, including the suction pipe.
- Close the air regulation screw clockwise all the way (to position `0`)
- Turn the air regulation screw back to its normal position.
Ready!



fig. 14

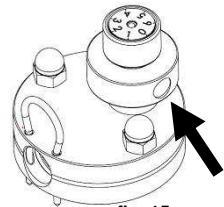

fig. 15



Master Cleaning and technical checking

Provided all instructions are followed in detail, the SANOMAT will operate without problems for a long time.

Nevertheless, should problems occur, a thorough cleaning and check-up must be carried out. When this is done, all parts subject to wear and tear must be exchanged.

Safety regulation

The inadvertent start-up of a unit taken apart is always dangerous! Therefore:

⚠ Before disassembling the unit, unplug power cord to prevent personnel injury and damage to the equipment!

Preparation

- Have all parts and tools ready, that are needed for the taking-apart, cleaning and reassembly:
 - a) Equipment set supplied with the unit (or re-ordered)
 - b) Tools and cleaning brushes supplied with the unit
 - c) Cream container from the SANOMAT
 - d) Vaseline
 - e) a paper clip
 - f) When taking the unit apart, carefully place all small parts in the cream container.

⚠ Losing a part results in downtime of the unit until a replacement can be obtained!

Conduct a proper disinfection-cleaning and cleaning of air regulation (see page 20), but:

Do not reassemble the unit at this time!

- Remove hand nut from magnetic valve, lift-up the magnet-coil and let it hang by its cable. (fig. 16)

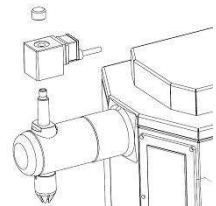

fig. 16

SANOMAT

Cream whipping machines



- With the wrench, unscrew the upper closing unit and lift-out the magnetic core and spring. (fig. 17)
- Remove garnishing nozzle and remove locking device from air regulation. Turning lightly pull cream whipping assembly out of its housing. (fig. 18)
- With the locking device, push in the locking bolt and with light turns, pull away the outlet part. (fig. 18)
- With the locking device, push in the other locking bolt and pull-out the inlet part. (fig. 19)
- Slide the pushing rod into the whipping pipe and push-out the inlet part, the 13 whipping discs (plastic) and 12 intermediate discs (metal) (resp. the whole whipping column) (fig. 20)
- With a turn, pull the strainer off the suction pipe.
- With the socket wrench remove the hexagon nuts from the valve head.
- Lift-off valve head and the steering disc and pull-out the pump. (fig. 21)
- **Do not disassemble pump!**
- Remove **all** O-rings. For O-rings on the inside, you should use the paperclip. Discard **all** removed O-rings! (fig. 22)

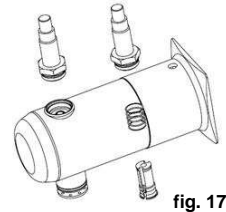

fig. 17

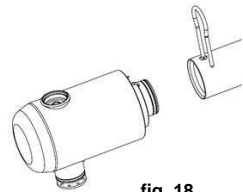

fig. 18

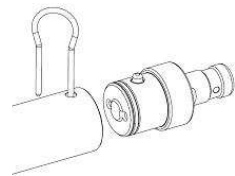

fig. 19

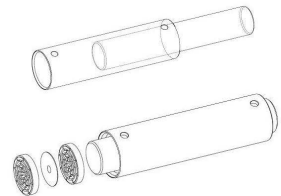

fig. 20

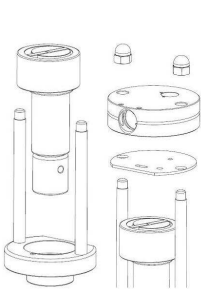

fig. 21

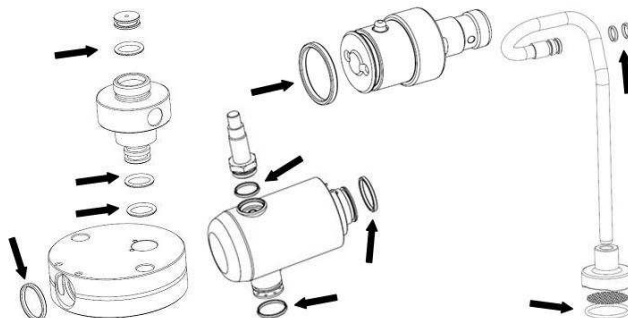

fig. 22



Cleaning

- Put a fine sieve in the drain of the sink, to prevent losing a small part which would result in downtime of the unit until a replacement can be obtained!
- Fill a bowl with hot water and add a few drops of SANO-DESINFEKT-Plus.

⚠ Do not use any other cleaning agents!

- Clean all parts in this solution.
- Clean all cavities thoroughly with the fitting brushes (equipment set, additional supply)

⚠ Do not use any cleaning tools that could leave scratches!

- Clean the grooves for the O-rings very thoroughly.
- Rinse pump very thoroughly while turning rotor. **Do not take the pump apart!**
- Rinse all parts once more with running hot water. Dry all parts with a clean, lint-free cloth accurately.

Testing

- Check that the pump-rotor turns easily and that all parts appear in good condition.
 - Exchange questionable parts by new ones!
- ➔ Poor or infrequent carrying-out of the disinfection cleaning could have resulted in corrosion on surfaces.

Do not reinstall questionable parts!

If you are not sure: Ask the after sale service of the manufacturer or your dealer!

Re-assembly

- Put-on **all** new O-rings and make sure, that the O-rings fit properly! Lightly apply Vaseline to all new O-rings.

⚠ One missing or poorly placed O-ring can lead to a leak or malfunction!

- Install the pump. It must fit properly into the flange.
 - **Before make sure that:**
- ➔ the pump coupling matches the motor coupling (if applicable turn into right position.

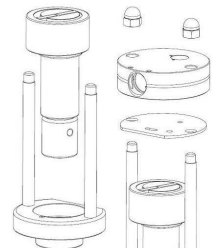

fig. 23



- ➔ the 2 bolts of the pump flange are differently thick. Pump can only be adjusted in one direction.
- Put-on the steering disc (check fixation!) and then valve head. (fig. 23)

Re-assembly of the whipping pipe:

Tip: When re-assembling the whipping pipe always begin with a whipping disc (plastic) and end with a whipping disc.

- Hold the whipping pipe in vertical position (the side with the gasket on top) and insert the pushing rod from the bottom. Insert a whipping disc, add an intermediate disc (cone down). Alternating, add the remaining whipping discs (13 pcs.) and intermediate discs (12 pcs.), resp. insert the entire whipping column. (fig. 24)
- Push the outlet part up to the stop onto the whipping pipe and push in locking device into the outlet part. (fig. 25)
- Turn the outlet part and whipping pipe upside-down, so that the pushing rod is on top and remove the pushing rod.
- Insert the inlet part into the whipping pipe. (fig. 26)
- Slide the whipping assembly into the housing, turning lightly. Turn and move the whipping pipe back and forth until the locking device can be inserted all the way. (fig. 27)
- Put on the hexagon nuts and tighten them alternately by hand.
- Place the spring and the magnetic core in the upper closing unit and with the wrench screw the upper closing unit onto the outlet part. (fig. 17, page 22)
- Place magnet coil and hand nut on the upper closing unit. (fig. 16, page 21) Tighten hand nut and slide-on garnishing nozzle.
- Insert the air regulation case, turning lightly until it locks into the correct position:

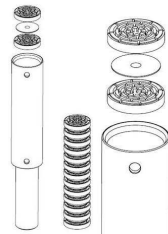

fig. 24

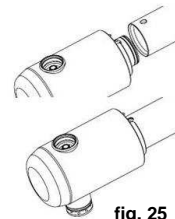

fig. 25

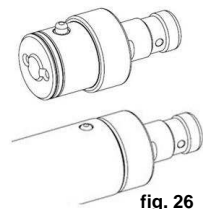

fig. 26

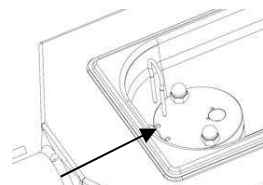

fig. 27

⚠ The hole for suction pipe goes to the right, not to the back!

•

SANOMAT

Cream whipping machines



- Put-in the non return valve and the air nozzle disc. Put on the air regulation screw. (fig. 28)
- Turn air regulation screw in all the way and then back to its usual position.
- Slide strainer onto the suction pipe and install it. Swing it in.
- Put on cover, plug-in power plug and turn the SANOMAT on - it's now ready for operation and you can switch between the day and night mode.

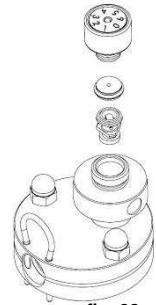

fig. 28



Setting parameters

- to be done only by authorised personnel! -

- Switch the SANOMAT into night mode
 - Type in the password 1-2-3-2-1 by using the portion keys 1 - 3 and confirm with the hand key
 - If the password was entered correctly „P1“ appears at the display. With the portion key 3 you can jump to the next parameter, with portion key 1 and 2 you can change the value. Should you have changed a value the display jumps back into the parameter level after 3 seconds, what affirms the changing.
- ☞ Should no key be used within 60 seconds the SANOMAT automatically jumps back into the night mode. You can leave the parameter level by pushing button stop at anytime.
- ☞ A wrong password is signalised by a buzzer sound.

Example:

Would you like to be reminded of the daily disinfection cleaning at a special time?
No problem!

- ⇒ switch into the night mode
- ⇒ type in the password 1-2-3-2-1 and confirm with the key hand
- ⇒ jump using portion key 3 to parameter 10
- ⇒ type in the wished value by portion keys 1 and 2 (up and down), e.g. 18 for 6 pm or 20 for 8 pm
- ⇒ as soon as the display jumps back into the parameter level the value is applied
- ⇒ leave the parameter level by pushing key stop.

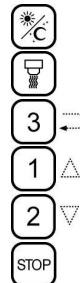

The following values in the chart are set by the work. Please record your changings and your own values in the provided column.

Cream whipping machines



para-meter	function-description	tuning range	factory setting	means	Your value
P1	Dosage time 1	1 sec. up to max. 100 sec.	1 sec.	ca. 20 g using 32% fat cream	
P2	Dosage time 2	1 sec. up to max. 100 sec.	1,5 sec.	ca. 30 g using 32% fat cream	
P3	Dosage time 3	1 sec. up to max. 100 sec.	2 sec.	ca. 40 g using 32% fat cream	
P4	Dosage time 4 for HAND key plus PORTION1 key	1 sec. up to max. 100 sec.	12 sec.	----	
P5	Minute	0 ... 59		----	
P6	Hour	0 ... 23		----	
P7	Day	1 ... 31		----	
P8	Month	1 ... 12		----	
P9	Year	2007 ... 2099		----	
P10	Cleaning demand	0 ... 23 time controlled 24: deactivated	24	e.g. 18 for 6 pm*	
P11	Key sound	0: without sound 1: with sound	1	----	
P12	Running text speed	1 ... 10 fast ... slow	5	----	
P13	Buzzer	0: buzzer off; key sound enabled 1: buzzer on	0	----	
P14	Display intensity	1 ... 10	6	----	
P15	Automatic summertime/wintertime	0: no automatic switching 1: automatic switching	1	----	
P16	Language	0: German 1: English 2: Italian	1	----	

* In Europe we use 24 hours - If you would like to start the cleaning at 3 pm please type in "15". For 8 pm please type in "20"



The parameters in detail:

P1, P2, P3: Dosage times (portion sizes)

- ☞ Here you are able to enter the dosage times related to the portion keys [PORTION1], [PORTION2] and [PORTION3].

P4: Dosage time (time controlled cream taking)

- ☞ Should the keys [HAND] and [PORTION1] be pushed together, cream is taken for the time adjusted under value P4.

P5 bis P9: Setting time

- ☞ Settings for the real-time clock

P10: Cleaning demand

- ☞ The cleaning demand appears at the chosen hour (0..23).

P11: Key sound

- ☞ Here the key sound of a pushed key can be switched on or off.

P12: Running text

- ☞ Here the speed of the running text is adjusted.

P13: Buzzer

- ☞ The buzzer can be disabled. Key sounds still work independently.

P14: Brightness

- ☞ With P14 the brightness of the display can be setted from 1 (dark) up to 10 (bright).

P15: Summer-/wintertime

- ☞ The automatic switching between summer and winter time can be enabled or disabled here.

P16: Language

- ☞ German, English, Italian and Dutch can be selected here.



Troubleshooting

The pump is running, but no whipped cream comes out	
• Is the cream container empty?	⇒ Put cream into the container!
• Are the nuts on the valve head loose?	⇒ Alternately tighten nuts!
• Is the magnet valve clotted?	⇒ Conduct a master cleaning and technical checking!
• Is there whipped cream in the cream container?	⇒ Remove cream. ⇒ Carry-out disinfection cleaning.
The pump is dry	⇒ Give some liquid through the opening of valve head to air regulation
The whipped cream is not perfect or not stable	
• Was the cream frozen or too warm?	⇒ Fill in new cream with a temperature about +3°C and +5°C (35-40°F)! ⇒ Air regulation is blocked! Disassemble valve into 3 parts and clean it.
• After some time, did the cream settle?	⇒ Stir cream well!
• Is the cream too sweet?	⇒ Remove cream! ⇒ Prepare and add fresh cream!
• Is homogenised cream ("H-cream") used?	⇒ Try a different sort!
• Wasn't the SANOMAT cleaned properly?	⇒ Carry-out disinfection cleaning
• The cream comes out liquid?	⇒ Check and clean the air regulation
The portions are unbalanced	
• Are the portions unbalanced?	• Check that air regulation and O-rings are firmly seated!
The portion keys do not react	
• Are you in the night mode?	• Switch into day mode
Alarm messages	
Temperature alarm	
• Should the allowed cream temperature exceed the notification „temperature alarm“ appears → please have also a look at page 9	
Sensor error cream-sensor	
• Cream-sensor malfunction (short circuit/break) → please contact your dealer or manufacturer	

**Sensor error vaporiser-sensor**

- Vaporiser-sensor malfunction (short circuit/break) → please contact your dealer or manufacturer

Should there be a sensor error your SANOMAT S-class switches into an emergency operation program. This means the cooling is provisory kept up. However a limited use of the machine is possible until it will be repaired. Please note that you must always have a look at the cream temperature in this case. In any case please contact immediately your dealer or manufacturer, otherwise bacteria and germs can easily be formed.

EP error! Memory error! Contact your dealer!

- An error at the parameter memory has appeared → please contact your dealer or manufacturer

No or the wrong time is shown?

- Should the machine have been out of power for four weeks or longer the time gets lost → you can set it at parameter P5-P9



Shipping Information

If you need to move the SANOMAT to a different location, or want to leave it with someone else, the following is very important:

Pass along operating instructions and all supplies and parts that came with the unit!

Always transport SANOMAT in upright position! If moved on its side, damage to the refrigeration unit may result!



Remember to let the unit stand idle for 2 hours before starting again!
This time is needed for the refrigeration unit to recover from movement during transport!

Disposal Instructions

Refrigeration units always contain chemical refrigerants. Therefore, at the end of their service life, they must be disposed of according to regulations!

⚠ Never put machine into household garbage!

The manufacturer will take back your old cream machine and dispose it according to the regulations!

Technical data

Model.....	SANOMAT-S2/S5/S10
Dimensions without outlet (WxDxH) (S2)	25,5cm x 35cm x 43cm
Dimensions without outlet (WxDxH) (S5)	30,5cm x 45cm x 49cm
Dimensions without outlet (WxDxH) (S10)	30,5cm x 45cm x 51,5cm
Weight	ca. 29kg / 38,5kg
Power	230V/50Hz // 110-120V/60Hz // 100V/50/60Hz
Power consumption (total).....	730W
Nominal load.....	200W
Fuse.....	min. 10A // min. 15A
Noise level (varies with working environment)	<70dB (A)
Capacity cream container.....	2,0 Liter
Cream temperature (thermostatically controlled)	5-7°C
Temperature group.....	N
Coolant	R134a/68g
Maximum allowable extra pressure (cooling system).....	43bar
Electrical protection class (II)	IP X1 (IP 65 / IP 00)

—

RMF002-1

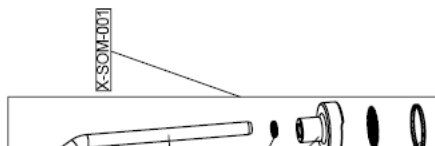

SANOMAT

Cream whipping machines

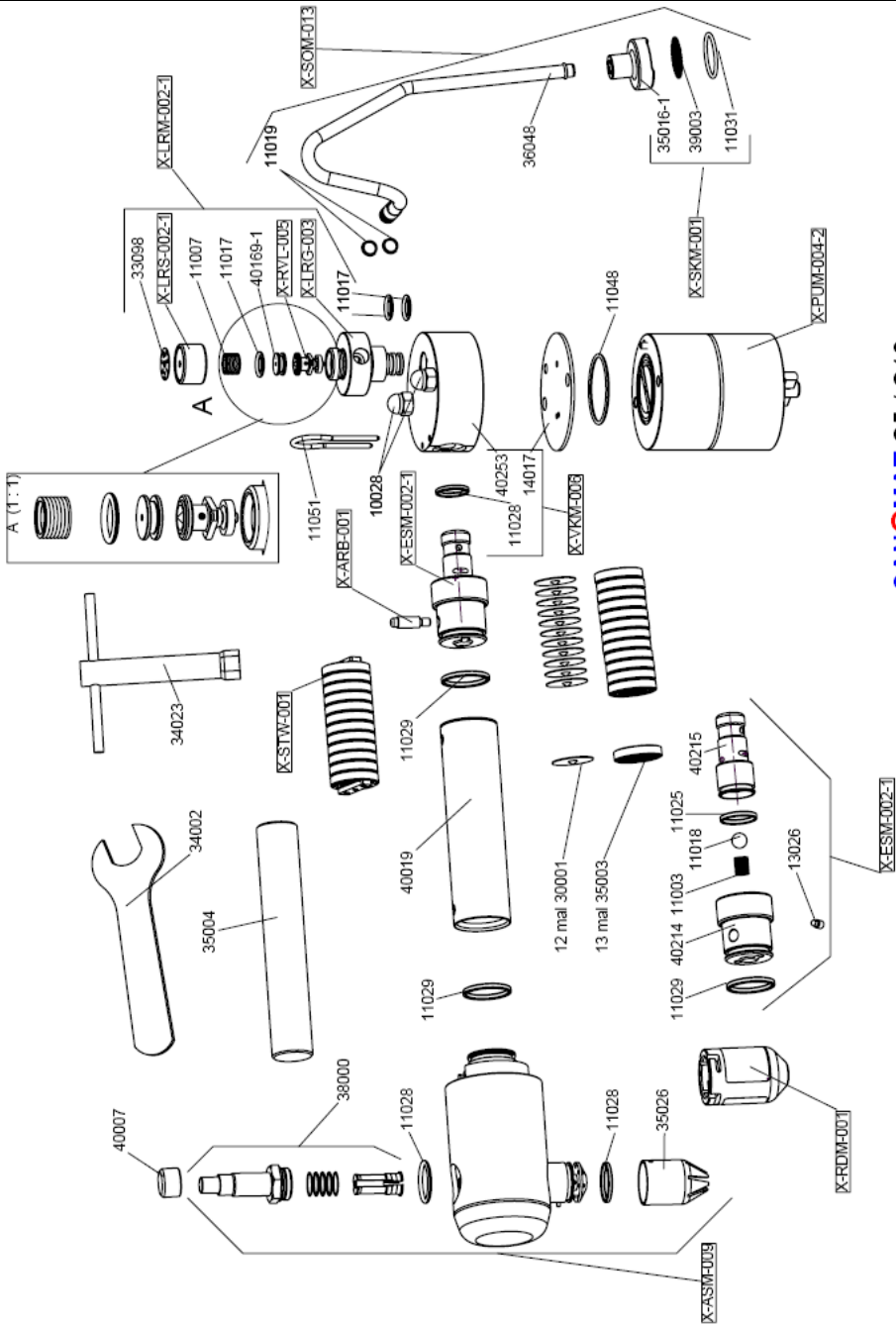

SANOMAT S5 / S10



Order numbers

Order Number	Description	
40 007	Knurled Nut	
38 000	Upper Closing Unit mounted	
X-ASM-002	Outlet Part mounted S2	
X-ASM-009	Outlet Part mounted S5/S10	
35 026	Garnishing nozzle	
X-RDM-001	Cleaning nozzle mounted	
X-ESM-002-1	Inlet Part mounted	
X-ARB-001	Locking Bolt	
40 019	Whipping Pipe	
35 003	Whipping Disc (13 pcs)	
30 001	Intermediate Disc (12 pcs)	
40 049	Whipping Column (altern. for 30001+35003)	
X-STW-001	Whipping Disc Column (altern. for 30001+35003)	
X-LRM-002-1	Air Regulation mounted	
33 098	Scale for Air Regulation Screw "0-9"	
X-LRS-002-1	Air Regulation Screw mounted	
11 007	Pressure Spring	
40 169-1	Air Nozzle Disc	
X-RVL-005	Non Return Valve mounted	
X-LRG-003	Air Regulation Case	
11 051	Locking Device (fork)	
X-VKM-013	Valve Head (with steering disc) S2	
X-VKM-006	Valve Head (with steering disc) S5/S10	
10 028	Hexagon Nut	
14 019	Steering Disc S2	
14 017	Steering Disc S5/S10	
X-SOM-001	Suction pipe mounted S2	
X-SOM-013	Suction pipe mounted S5/S10	
X-SKM-001	Strainer mounted	
39 003	Sieve	
X-PUM-007	Pump mounted S2	
X-PUM-004-2	Pump mounted S5/S10	
35 004	Pushing Rod	Tool
51 008 (no fig.)	Set of Gaskets	
34 002	Jaw Wrench	Tool
34 023	Socket Wrench	Tool
34 004 (no fig.)	Cleaning Brush (medium)	Tool
34 003 (no fig.)	Cleaning Brush (small)	Tool
34 036 (no fig.)	Cleaning Brush (mini)	Tool
50 009-2 (no fig.)	Set of cleaning brushes	



Declaration of Conformity

according to machine EC-directive 2006/42/EG

We declare the construction of the following cream whipping machines meet the corresponding regulations:

SANOMAT S-Klasse 2/5/10

2006/42/EC Machinery Directive

2006/95/EC Electrical equipment designed for use within certain voltage limits

2004/108/EC Electromagnetic Compatibility (EMC)

EC No 1935/2004 on materials and articles intended to come into contact with food

EU No 10/2011 on plastic materials and articles intended to come into contact with food

DIN EN 60204-1:2007-06 Safety of machinery - Electrical equipment of machines - Part

1: General requirements

DIN EN 55014-1:2012-05 EMC Requirements for household appliances, electric tools and similar apparatus. Emission

DIN EN 55014-2:2009-06 EMC Requirements for household appliances, electric tools and similar apparatus. Immunity

DIN EN 61000-3-2:2010-03 EMC Limits. Limits for harmonic current emissions

DIN EN 61000-3-3:2014-03 EMC. Limits. Limitation of voltage changes, voltage fluctuations and flicker

DIN EN 82079 Preparation of instructions for use. Structuring, content and presentation.

DIN 10507 food hygiene - Charge cream machine

VDI 4500 Technical Documentation

GPSG Equipment and Product Safety Act

Bad Camberg, May 2015

Undersigned:

Bernd Rehbein

© 05/2015 Vaihinger

Printed in Germany



Notes

Machine-type:

Machine-no°:

Bought on: __ . __ . ____

Bought from:

Register-no°:
